

ERGOHUMAN

CLASSIC

L'ERGONOMIE SUR-MESURE



Comfwork.



L'innovation au service de votre dos



APPUI-TÊTE

L'appui-tête peut être incliné et ajusté en hauteur selon les besoins de l'utilisateur.

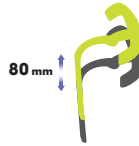

80 mm

Appui-tête
Hauteur



35°

Appui-tête
Angle

DOSSIER

Hauteur
Réglable
6 positions



ACCOUDOIRS Entièrement réglables 4D

Hauteur



Profondeur



Largeur



Angle



ASSISE AJUSTABLE

Mécanisme synchrone
4 positions



Translation d'assise
50 mm



Assise négative
Inclinaison vers l'avant
Dossier 6°
Assise 2°



CONTRÔLE DE TENSION

Contrôle de tension de haute technologie de 8 à 12 kg.

Tension faible
8 kg



Tension forte
12 kg

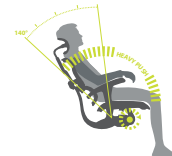

Tension lombaire
Réglable



Sièges de bureau
pour les personnes
pesant jusqu'à 110 kg.

LÉGER
0 %

FORT
40 %



UTILISATION ET FONCTIONNALITÉS



Scannez ce QR code
pour accéder à plus
d'informations



YouTube

@ comfwork

www.comfwork.fr



Caractéristiques et certifications

ACCOUDOIRS 4D	●
ASSISE NÉGATIVE	●
TRANSLATION D'ASSISE	●
SOUTIEN LOMBAIRE	●
APPUI-TÊTE 2D	●
RÉGLAGE DE LA HAUTEUR DU DOSSIER	●
MÉCANISME SYNCHRONE	●
PIÈTEMENT ALUMINIUM	●

CERTIFICATION GREENGUARD La certification Greenguard standard a des normes établies pour définir les produits et les procédés à faible teneur en produits chimiques et en particules pour une utilisation en intérieur.	Gold	
RECYCLABILITÉ	91 %	
ANALYSE DES MATÉRIAUX	Contenu	Recyclé
Plastique	52,98 %	29 %
Alliage en aluminium	33,56 %	10 %
Acier	4,90 %	10 %
Tissu ameublement	3,86 %	-
PU/Mousse	4,70 %	-
TOTAL MATÉRIAUX RECYCLÉS	20%	
CERTIFICATION EN 1335		
-1:2020	Oui	
-2:2018	Oui	
ANSI/BIFMA X5.01-2017	Oui	



COMPOSITE POLYMÈRE FONCTIONNEL

 **Réduction**
de la pollution
de l'air intérieur

 **Plus**
ferme

 **Surface**
de meilleure
qualité

 **Plus**
léger

DIMENSIONS (EN MM)



Structure Ergohuman Gris/Noir

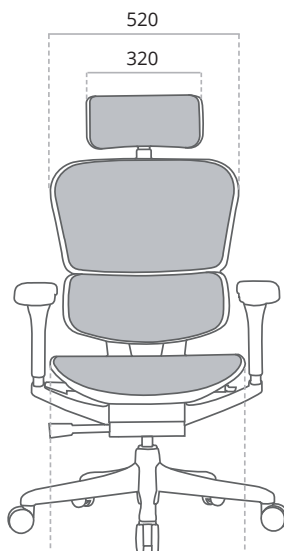

510

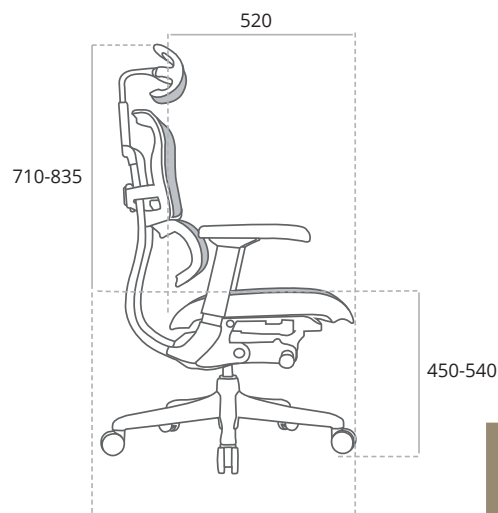

700



Plan de montage

et contenu

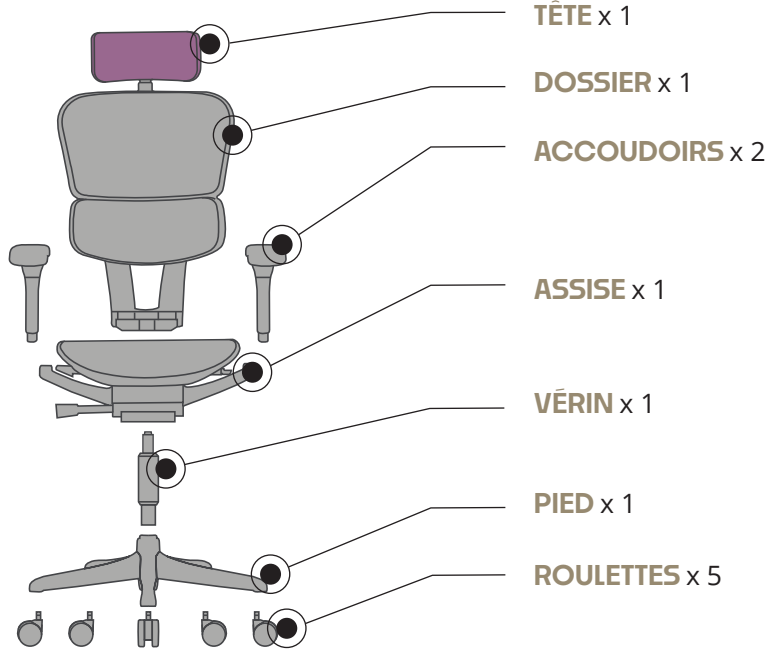

Ergohuman Classic est composé à 20 % en matière recyclée. Il est recyclable à 97 %. Il est certifié Greenguard Gold et répond aux normes EN 1335-1:2020 et EN 1335-2:2018.

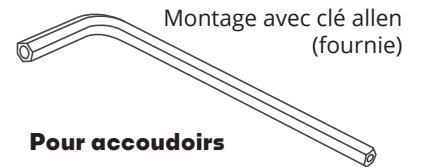

Pour accoudoirs

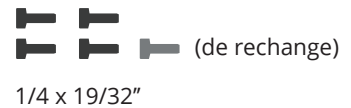

Pour dossier

